



Sauberkeit und Hygiene
aus Leidenschaft!



LUXURY HYGIENE SOLUTIONS

PRODUKTKATALOG



Sauberkeit und Hygiene aus Leidenschaft !



**CARTIERE
CARRARA**

ÜBER UNS

CARTIERE CARRARA, ist heute einer der führenden europäischen Hersteller und Verarbeiter von Tissue-Papier. Das integrierte Verfahren ermöglicht es dem Konzern, sowohl Mutterrollen als auch Fertigprodukte zu produzieren. Hergestellt wird ein Gesamtangebot für den professionellen Markt, als auch für den Einzelhandel. Die Gruppe exportiert in über 40 Länder weltweit.

Cartiere Carrara ist mit einer jährlichen Produktion von 200'000 Tonnen Tissue-Papier auf Platz 6 unter den Herstellern in Europa. Die gesamte Produktion findet ausschliesslich in Italien statt. 400 Mitarbeiter in 9 Fabriken produzieren Toilettenpapier, Handtücher, Reinigungsrollen, Küchenrollen, Taschentücher, Servietten, Tischdecken und Bestecktaschen.



Sauberkeit und Hygiene aus Leidenschaft !



NACHHALTIGKEIT

**CARTIERE CARRARA,
UNSERE PHILOSOPHIE FÜR EINE NACHHALTIGE ZUKUNFT**

Cartiere Carrara widmet der Ethik und der nachhaltigen Produktion grösste Aufmerksamkeit. Eine ganze Reihe von Zertifizierungen bringen diese Anstrengungen zum Ausdruck, so zB: **ECOLABEL • NORDISCHES UMWELTZEICHEN • PEFC • FSC • ISO14001**

Unsere **ISEGA**-zertifizierten Produkte sind für den Kontakt mit Lebensmitteln geeignet.

ARBEITS-ETHIK

Soziale Verantwortung **SA8000**.

Cartiere Carrara legt immer größten Wert auf den Schutz und die Rechte der beschäftigten Menschen und ist sich stets der Bedeutung sozialer Probleme in der Gemeinschaft, in denen sie tätig ist, bewusst. Deshalb entschied man sich, ein Management-System der sozialen Verantwortlichkeit zu übernehmen, in voller Übereinstimmung mit allen Regionalen, Nationalen und Internationalen Menschenrechtsstandards und der SA8000:2008 (Social Accountability 8000).

SA8000 ist der internationale Zertifizierungsstandard, der die freiwilligen Anforderungen definiert, die der Arbeitgeber am Arbeitsplatz respektieren muss, einschließlich der Arbeitnehmerrechte, die Bedingungen des Arbeitsplatzes und die Managementsysteme.

ZERTIFIZIERTE QUALITÄT

BEIM VERFOLGEN UNSERER ZIELE RESPEKTIEREN WIR DIE UMWELT

Cartiere Carrara hat sich stets dafür eingesetzt, eine nachhaltige Zukunft für die Umwelt zu sichern, CO₂-Emissionswerte einzuhalten, den geringstmöglichen Wasserverbrauch zu gewährleisten und sich der Minimierung des Energieverbrauchs zu verpflichten.



**-KW
-H₂O**

REDUKTION DES ENERGIEVERBRAUCHS

REDUZIERUNG DES WASSERVERBRAUCHS



Sauberkeit und Hygiene aus Leidenschaft !



ZERTIFIZIERTE
QUALITÄT



Wir verwenden ausschliesslich
ZERTIFIZIERTES PAPIER

Im Mittelpunkt unserer Projekte
STEHEN IMMER DIE MENSCHEN





Sauberkeit und Hygiene aus Leidenschaft !



BRAND

ALL IN ONE

- HOReCA
- MEDICAL & HEALTHCARE
- ENTERTAINMENT
- OFFICE
- CONTRACT CLEANING
- INDUSTRY
- FOOD PROCESSING

EXCELLENCE

Produkte von höchster Qualität für höchste Ansprüche.

PREMIUM

Qualitativ hochwertige Produkte mit sehr gutem Preis-Leistungs-Verhältnis.

CLASSIC

Hochwertige Produkte zum attraktiven Preis.

COMFORT

Produkte mit durchschnittlicher Qualität, für Umgebungen mit hoher Freqüentierung und niedrigem Kostenaufwand.

BULKYSOFT® BUSINESS TO BUSINESS

Die Abteilung "Professional" ist mit der Aufgabe betraut, Antworten auf die Bedürfnisse und Wünsche der Endkunden zu finden.

Die Produkte der Marke Bulkysoft wurden entwickelt, um die Bedürfnisse von den Segmenten Ho.Re.Ca., Büro, Industrie, Volksgesundheit und Privatversorgung, Unterhaltung und Ästhetik gerecht zu werden, mit einem einzigartigen Sortiment von Tissueprodukten, Spendern und Zubehör.

WASHROOM

06



**MEDICAL &
HEALTH CARE**

15



WORKPLACE

18



TABLE TOP

22



STARTER KIT

32



SYSTEMS

34

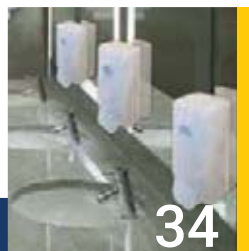

WASHROOM



WASHROOM TOILETTPAPIER



TOILETTPAPIER KLEINROLLEN

COD. 66400 EXCELLENCE
BULKYSOFT TOILETTPAPIER 6 ROLLEN
WEISS



4



100%
Pure



SONNE



6 x 10



150



13,5x9,5 cm



28

COD. 66300 EXCELLENCE
BULKYSOFT TOILETTPAPIER 8 ROLLEN MAXI
WEISS



3



100%
Pure



PLUS



8 x 9



250



13,2x10 cm



18

COD. 66520 EXCELLENCE
BULKYSOFT TOILETTPAPIER 8 ROLLEN
WEISS



3



100%
Pure



PLUS



8 x 9



250



11,5x9,5 cm



18

COD. 66430 EXCELLENCE
BULKYSOFT TOILETTPAPIER 8 ROLLEN
WEISS



3



100%
Pure



PLUS



8 x 12



200



11,5x9,5 cm



21

COD. 66770 EXCELLENCE
BULKYSOFT TOILETTPAPIER 8 ROLLEN
WEISS



3



100%
Pure



PLUS



8 x 12



150



10,5x10 cm



21

COD. 66550 EXCELLENCE
BULKYSOFT TOILETTPAPIER EINZELN VERPACKT
WEISS



3



100%
Pure



PLUS



4 x 24



150



10,5x9,5 cm



20

COD. 66440 CLASSIC
BULKYSOFT TOILETTPAPIER 4 ROLLEN COMPACT
WEISS



2



100%
Pure



OHNE



4 x 10



500



10,5x10 cm



40

COD. 66991 COMFORT
BULKYSOFT TOILETTPAPIER 12 ROLLEN
WEISS



2



Zellstoff



BLUME



12 x 8



130



11x9 cm



22

WASHROOM

TOILETTPAPIER



TOILETTPAPIER JUMBO

COD. 65006 PREMIUM
BULKYSOFT TOILETTPAPIER MINI JUMBO
 SPENDER 01100 WEISS



COD. 65005 PREMIUM
BULKYSOFT TOILETTPAPIER MAXI JUMBO
 SPENDER 01090 WEISS



COD. 65501 CLASSIC
BULKYSOFT TOILETTPAPIER MINI JUMBO
 SPENDER 01100 WEISS



COD. 65901 PREMIUM
BULKYSOFT TOILETTPAPIER MAXI JUMBO
 SPENDER 01090 WEISS



COD. 01100 BULKYSOFT
 SPENDER FÜR MINI JUMBOROLLEN

Transp. WEISS

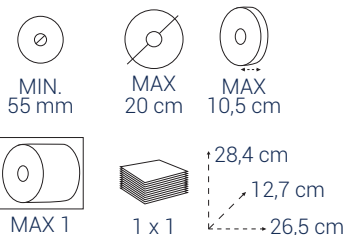

COD. 01090 BULKYSOFT
 SPENDER FÜR MAXI JUMBOROLLEN

Transp. WEISS

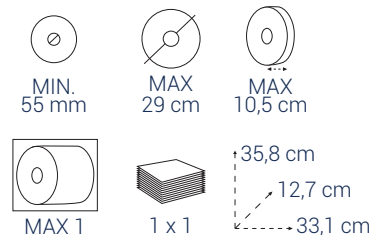

WASHROOM TOILETTPAPIER

VEREINFACHE DEIN LEBEN MIT **easyBag**

EINFACH ZU HANDHABEN	EINFACH ZU ENTSORGEN UND RECYCELN
EINFACH ZU VERSTAUEM	EINFACH ZU ÖFFNEN
BESTÄNDIG	UNDURCHLÄSSIG
WENIGER VERPACKUNG	LEICHT ZU TRANSPORTIEREN

NEUE VERPACKUNG



TOILETTPAPIER EINZELBLATT

COD. 67582 EXCELLENCE
BULKYSOFT TOILETTPAPIER EINZELBLATT - EASYBAG
SPENDER 01110 WEISS

easyBag



	2		100% Pure		DIAMOND
	19x11 cm		250x24		72

COD. 01110
BULKYSOFT
SPENDER FÜR EINZELBLATT TOILETTPAPIER

Transp. WEISS

	MAX 11 cm		MAX 11,3 cm
	MAX 2		1 x 1
			27,5 cm 12,1 cm 13,5 cm



TOILETTPAPIER EINZELBLATT

COD. 67540 PREMIUM
BULKYSOFT TOILETTPAPIER EINZELBLATT
SPENDER 01110 WEISS



	2		100% Pure		MICRO
	19x11 cm		250x36		48

WASHROOM

HOHE Leistung für eine bessere-Trocknung

- EIN HANDTUCH IST GENUG
- MAXIMALE SAUGFÄHIGKEIT
- BESSERE HYGIENE

PAPIERHANDTÜCHER



PAPIERHANDTÜCHER



COD. 84561 BULKYSOFT
SPENDER 01010 WEISS

easyBag

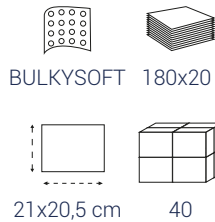

COD. 83451 BULKYSOFT
SPENDER 01020 WEISS

easyBag

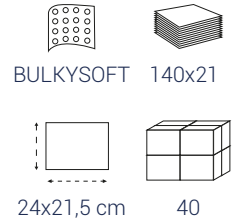

COD. 82311 BULKYSOFT
SPENDER 01020 WEISS

easyBag



COD. 86000 BULKYSOFT
SPENDER 01010 WEISS

easyBag

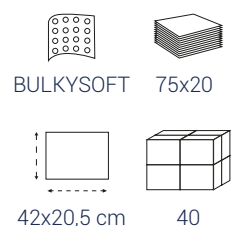

VEREINFACHE DEIN LEBEN MIT

easyBag

EINFACH ZU HANDHABEN	EINFACH ZU ÖFFNEN	EINFACH ZU ENTSORGEN UND RECYCLERN	EINFACH ZU VERSTAUEN
BESTÄNDIG	UN DURCHLÄSSIG	WENIGER VERPACKUNG	LEICHT ZU TRANSPORTIEREN

NEUE VERPACKUNG

WASHROOM PAPIERHANDTÜCHER



PAPIERHANDTÜCHER

COD. 84500 CLASSIC
BULKYSOFT V-FALZ
SPENDER 01010 WEISS

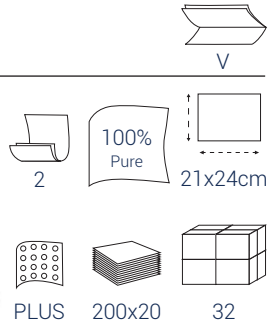

COD. 84450 CLASSIC
BULKYSOFT V-FALZ
SPENDER 01010 WEISS

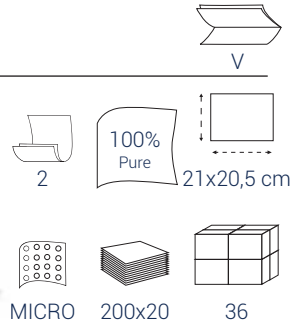

COD. 84520 CLASSIC
BULKYSOFT V-FALZ
SPENDER 01010 WEISS

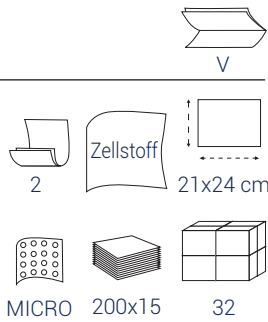

COD. 84460 CLASSIC
BULKYSOFT V-FALZ
SPENDER 01010 GRÜN

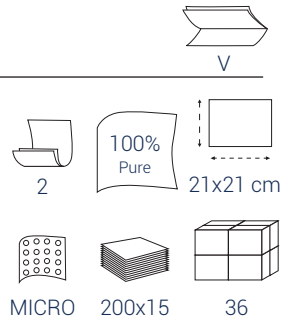

COD. 81150 EXCELLENCE
BULKYSOFT K4-FALZ
SPENDER 01010 WEISS

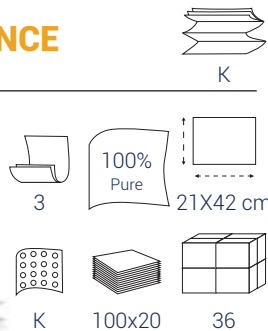

COD. 81140 EXCELLENCE
BULKYSOFT K4-FALZ
SPENDER 01010 WEISS



COD. 01010 BULKYSOFT
SPENDER FÜR PAPIERHANDTÜCHER - V- UND K-FALZ

Transp. WEISS

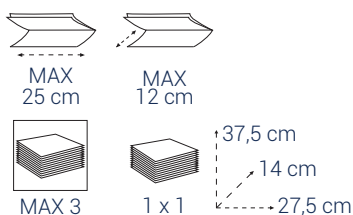

COD. 81100 EXCELLENCE
BULKYSOFT K2-FALZ
SPENDER 01010 WEISS

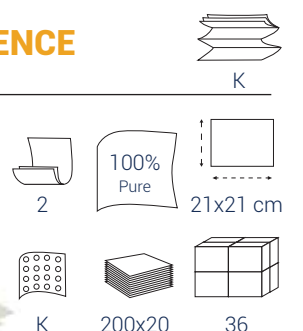

WASHROOM

PAPIERHANDTÜCHER



PAPIERHANDTÜCHER

COD. 85520 CLASSIC
BULKYSOFT C-FALZ
SPENDER 01020 WEISS

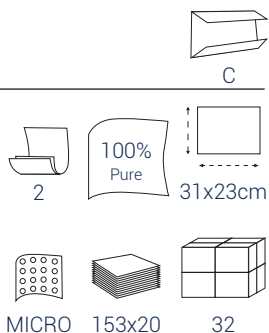

COD. 85510 CLASSIC
BULKYSOFT C-FALZ
SPENDER 01020 WEISS

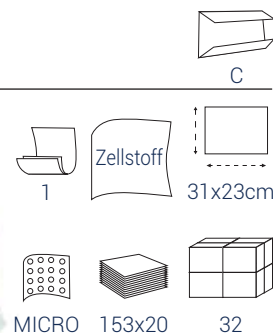

COD. 83400 PREMIUM
BULKYSOFT Z-FALZ
SPENDER 01020 WEISS

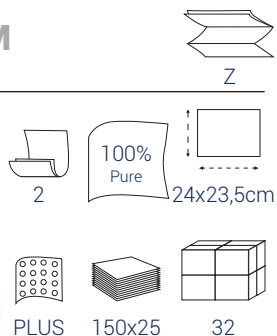

COD. 83390 CLASSIC
BULKYSOFT Z-FALZ
SPENDER 01020 BLAU

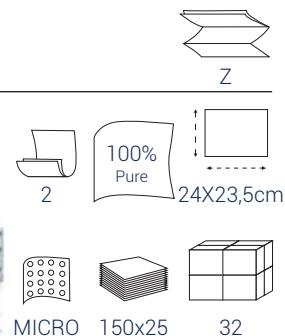

COD. 83350 PREMIUM
BULKYSOFT Z-FALZ
SPENDER 01020 WEISS

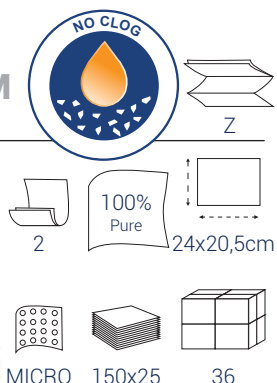

COD. 82260 PREMIUM
BULKYSOFT M-FALZ
SPENDER 01020 WEISS

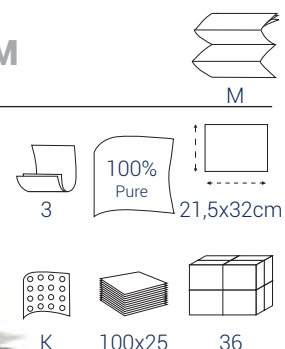

COD. 01020 BULKYSOFT
SPENDER FÜR PAPIERHANDTÜCHER - C- Z-UND M-FALZ

Transp. WEISS

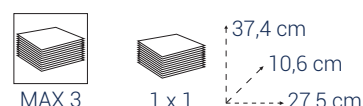
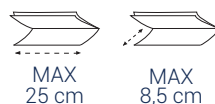

WASHROOM PAPIERHANDTUCHROLLEN



PAPIERHANDTUCHROLLEN FÜR AUTOCUT SYSTEM



COD. 98922
BULKYSOFT

CAPTIVE SYSTEM



SPENDER 01345

WEISS

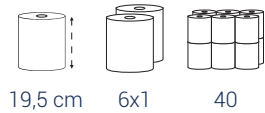
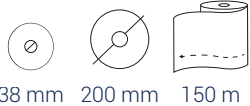

COD. 01345
BULKYSOFT

SPENDER AUTOCUT SYSTEM

WEISS

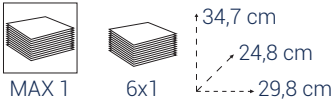
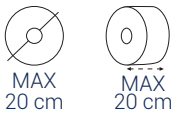

COD. 98905
BULKYSOFT

CAPTIVE SYSTEM



SPENDER 01140

WEISS

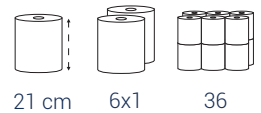
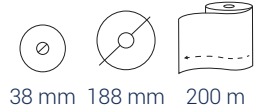

COD. 98904
BULKYSOFT

CAPTIVE SYSTEM



SPENDER 01140

BLAU

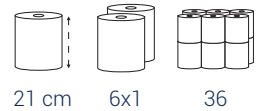
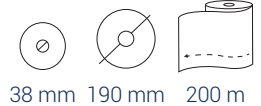

COD. 01140
BULKYSOFT

SPENDER AUTOCUT SYSTEM

WEISS

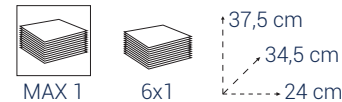
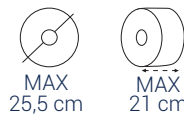

PAPIERHANDTUCHROLLEN

COD. 97770 **EXCELLENCE**
BULKYSOFT

WEISS

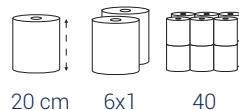
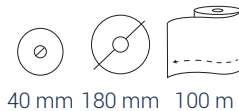

COD. 97780 **CLASSIC**
BULKYSOFT

WEISS

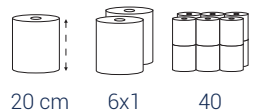
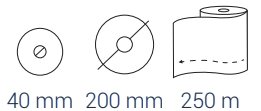

WASHROOM

ACCESSORIES

COD. 45690

BEFÜLLUNG FLÜSSIGSEIFE 'CRYSTAL BLUE'
SPENDER 01050

1000 12x1

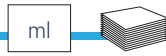

COD. 45700

BEFÜLLUNG FLÜSSIGSEIFE ANTIBAKTERIELL
SPENDER 01050

1000 12x1



COD. 45600

SCHAUMSEIFE
SPENDER 01040

1000 6x1

COD. 45610

BEFÜLLUNG RAUMDUFT • BLUMENDUFT
SPENDER 01150

100 12x1

COD. 45620

BEFÜLLUNG RAUMDUFT • CITRUSDUFT
SPENDER 01150

100 12x1

COD. 45630

BEFÜLLUNG RAUMDUFT • APFELDUFT
SPENDER 01150

100 12x1

COD. 45640

BEFÜLLUNG RAUMDUFT • EXOTISCHE FRÜCHT
SPENDER 01150

100 12x1

COD. 45650

BEFÜLLUNG RAUMDUFT • ASSORTIERTE DÜFTE
SPENDER 01150

100 12x1

COD. 45560

TOILETTENSITZAUFLAGEN.
SPENDER 01270

200X10

COD. 01270

BULKYSOFT
SPENDER FÜR TOILETTENSITZAUFLAGE

WEISS

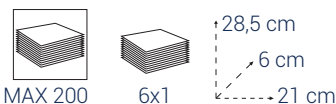

COD. 01050

BULKYSOFT
SEIFENSPENDER FÜR KARTUSCHEN

Transp. WEISS

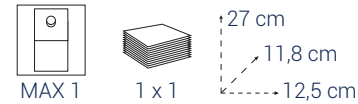

COD. 01040

BULKYSOFT
SCHAUMSEIFENSPENDER FÜR KARTUSCHEN

Transp. WEISS

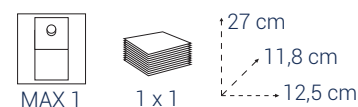

COD. 01150

BULKYSOFT
SPENDER FÜR RAUMDUFT

Transp. WEISS

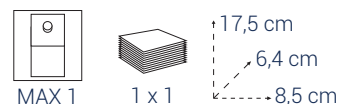

COD. 01280

BULKYSOFT
ABFALLBEHÄLTER MIT
SCHWENKDECKEL 30 LITER





MEDICAL & HEALTH CARE



ÄRZTEROLLEN

COD. 76540 BULKYSOFT PREMIUM

WEISS

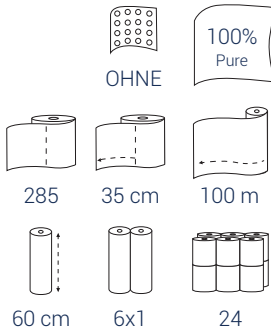

COD. 76560 BULKYSOFT CLASSIC

WEISS

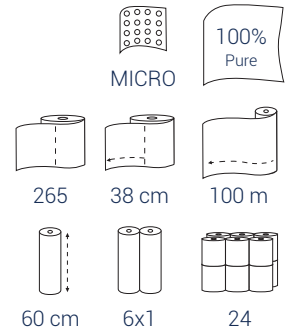

COD. 76502 BULKYSOFT PREMIUM

WEISS

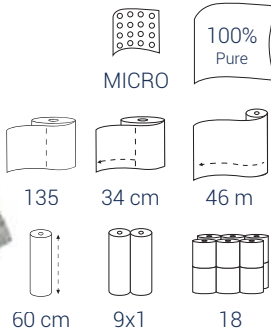

COD. 76530 BULKYSOFT PREMIUM

WEISS

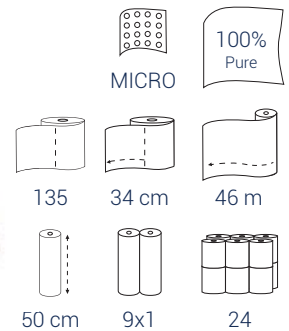

COD. 76712 BULKYSOFT PREMIUM

BLAU

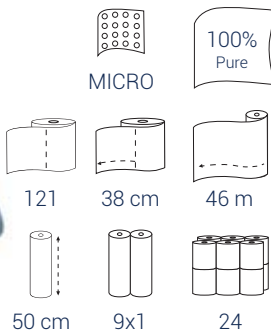

COD. 76509 BULKYSOFT PREMIUM

WEISS

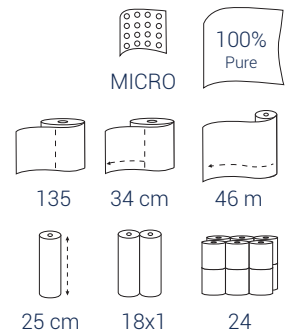

MEDICAL & HEALTH CARE



KOSMETIKTÜCHER

COD. 68100
BULKYSOFT CLASSIC
SPENDER 01250 WEISS

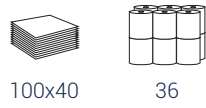
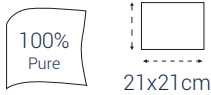

COD. 68350
BULKYSOFT
WEISS

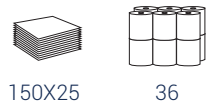
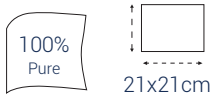

COD. 68360
BULKYSOFT
WEISS

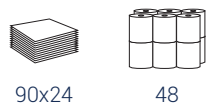
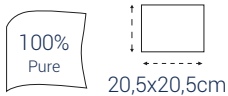

TASCHENTÜCHER

COD.69110
BULKYSOFT

WEISS

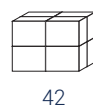
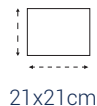

COD. 01250
BULKYSOFT
KOSMETIKTUCHSPENDER 100 STÜCK

WEISS

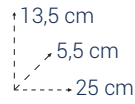
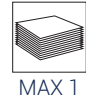

KOSMETIKTÜCHER

COD. 68903
BULKYSOFT PREMIUM
WEISS





WORKPLACE



KÜCHENROLLEN

COD. 28870 PREMIUM BULKYSOFT KÜCHENROLLEN TWINCOMPACT
WEISS

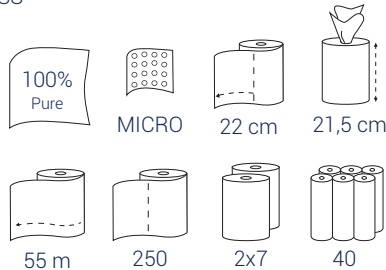

COD. 01130 BULKYSOFT
SPENDER FÜR MINI HANDTUCHROLLEN

Transp. WEISS

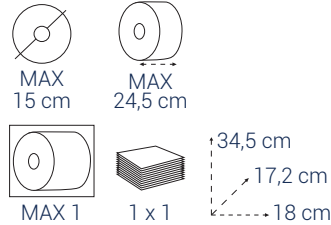

COD. 01120 BULKYSOFT
SPENDER FÜR MIDI H

Transp. WEISS

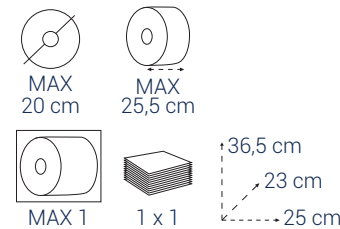

HANDTUCHROLLEN MIT INNENABWICKLUNG

COD. 96610 PREMIUM BULKYSOFT MINI
SPENDER 01130 WEISS

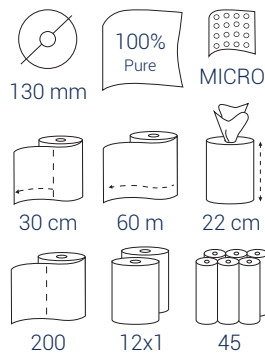

COD. 96600 PREMIUM BULKYSOFT MIDI
SPENDER 01120 WEISS

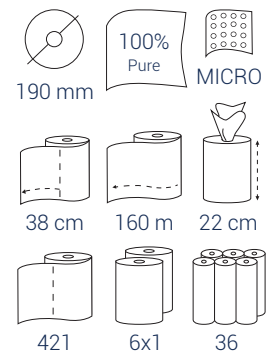

COD. 96606 PREMIUM BULKYSOFT MIDI
SPENDER 01120 BLAU

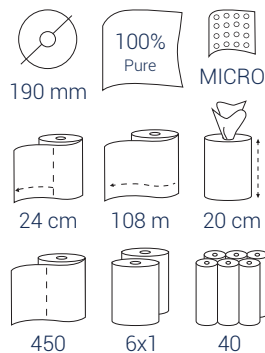

COD. 96640 CLASSIC BULKYSOFT MIDI
SPENDER 01120 WEISS

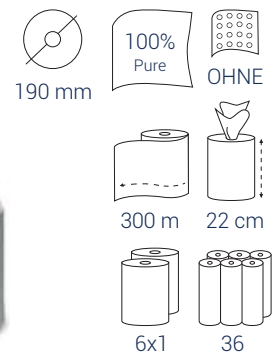

WORKPLACE



INDUSTRIE PAPIERROLLEN

COD. 57530 PREMIUM BULKYSOFT WIPER 380

SPENDER 01320

WEISS

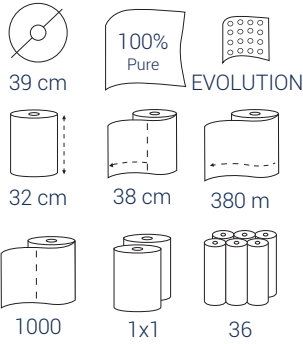

COD. 56320 EXCELLENCE BULKYSOFT WIPER 380 BLUE PROFESSIONAL

SPENDER 01320

BLAU

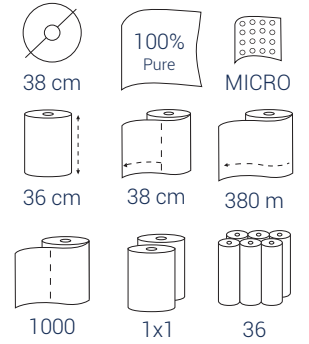

COD. 56460 EXCELLENCE BULKYSOFT WIPER 150 TOPLINE EVO

SPENDER 01320

WEISS

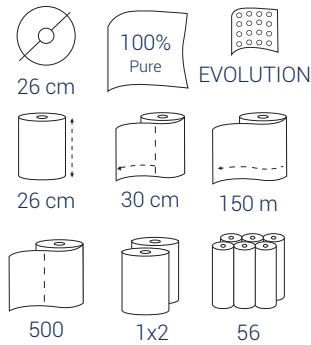

COD. 56760 EXCELLENCE BULKYSOFT WIPER 150 TOPCOLOR EVO

SPENDER 01320

BLAU

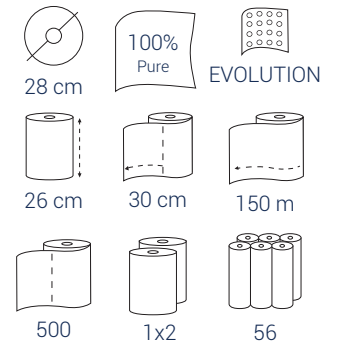



INDUSTRIE PAPIERROLLEN

COD. 56340 PREMIUM BULKYSOFT WIPER 380 BLUE PROFESSIONAL

SPENDER 01320

BLAU



2

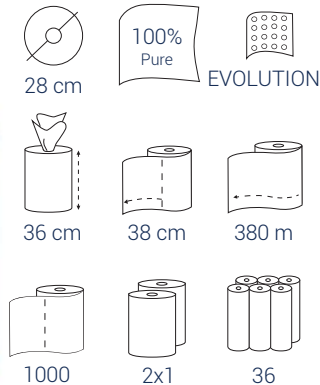

COD. 01300

BULKYSOFT

SPENDER FÜR INDUSTRIEROLLEN, GESCHLOSSEN, HACCP ZERTIFIZIERT

Transp. WEISS/BLAU



MAX 31 cm



41 cm
34,5 cm
MAX 1
35 cm



1 x 1



COD. 55104 CLASSIC BULKYSOFT WIPER 300 EVO

SPENDER 01300
01310
01320

WEISS



2

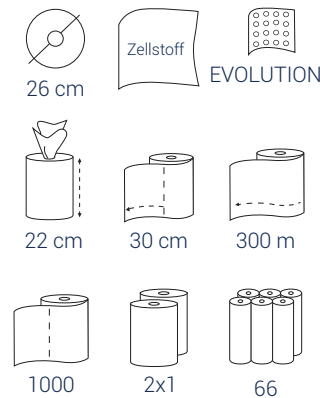

COD. 01310

BULKYSOFT

WANDHALTERUNG FÜR INDUSTRIEROLLEN CHROM

WEISS CHROM



MAX 34 cm



MAX 32 cm



38 cm
32 cm
MAX 1
24 cm



1 x 1



COD. 57590 CLASSIC BULKYSOFT WIPER 1000

SPENDER 01310
01320

WEISS



1

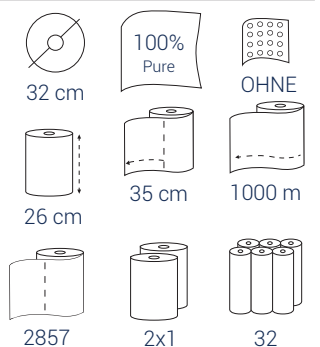

COD. 01320

BULKYSOFT

BODENSTÄNDER FÜR INDUSTRIEROLLEN

CHROM



MAX 37/38 cm



48 cm
46 cm
MAX 1
90 cm



1 x 1



TABLE TOP

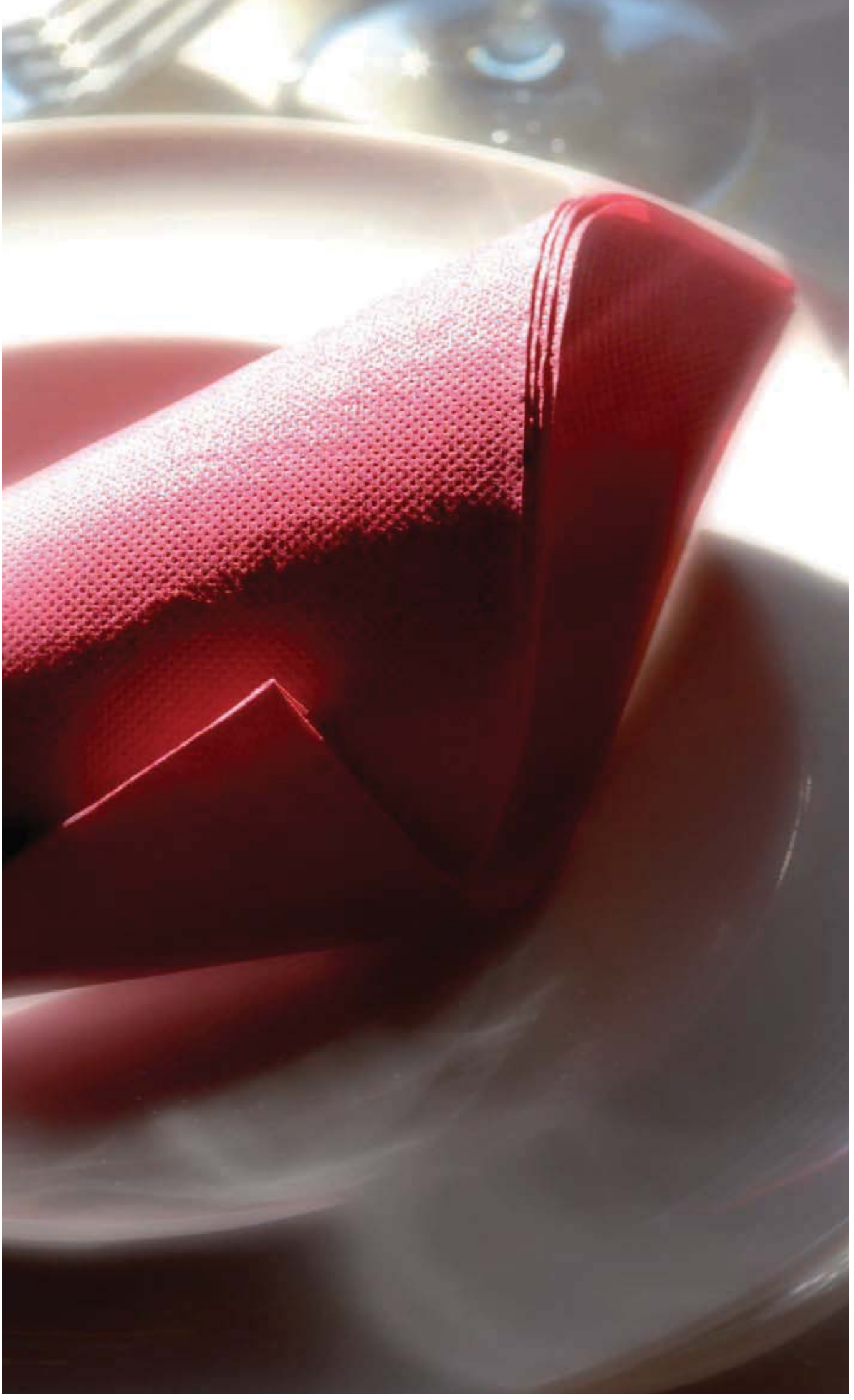

TABLE TOP

**Optimierter Verbrauch
& Garantierte Hygiene!**



COD. 01341
BULKYSOFT
SERVIETTENSPENDER
SYSTEM ONE
STAND MODEL



COD. 01342
BULKYSOFT
SERVIETTENSPENDER
SYSTEM ONE
TISCH MODEL



Anregungen...



OPTIMIERTER VERBRAUCH

Unsere Spender SystemOne ermöglichen es, den Verbrauch bis zu 30% zu reduzieren, durch die Ausgabe einer einzelnen Serviette.

UMWELT

Die Kombination von zertifizierten Produkten, wirtschaftlicher Einsparung und reduziertem Abfall trägt zur nachhaltigen Entwicklung der Umwelt bei.

GARANTIERTE HYGIENE

Jeder Spender SystemOne erlaubt die gesteuerte Versorgung einer Einzelserviette pro Gebrauch. Die speziell gefalteten Servietten garantieren absolute Hygiene und Funktionalität im Gebrauch.

EINSPARUNG VON KOSTEN UND ZEITMANAGEMENT

Der schnelle und einfache Wechsel ermöglicht Einsparungen bei Kosten- und Zeitmanagement.

COD. 01190
BULKYSOFT
SERVIETTENSPENDER



WEISS

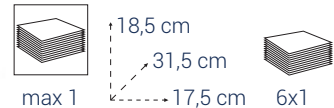

BULKYSOFT "SYSTEM ONE"

WEISS

COD. 32141 EXCELLENCE
BULKYSOFT SYSTEM ONE
SPENDER 01341 - 01342

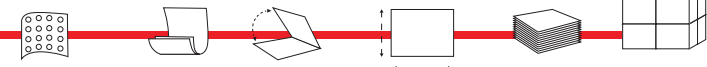

COD. 32040 EXCELLENCE
BULKYSOFT SYSTEM ONE
SPENDER 01341 - 01342



MICRO 3 1/2 21,5x16cm 200x20 42

COD. 32240
BULKYSOFT SYSTEM ONE PLUS
SPENDER 01341 - 01342



MICRO 2 1/2 21,5x16cm 200x20 42

COD. 32900
BULKYSOFT SYSTEM ONE
SPENDER 01341 - 01342



MICRO 2 1/2 19x14,5cm 200x24 48

COD. 32560
BULKYSOFT SYSTEM
SPENDER 01190



MICRO 1 1/2 19x14,5cm 300x24 48

FLÄCHE 1 1/4 27x30cm 400x10 32

TABLE TOP

SERVIETTEN



SERVIETTEN 24x24

COD. 32051
BULKYSOFT

SERVIETTEN 24x24
WEISS



1



1/4



100%
Pure



FLÄCHE



24x24cm



500x6



42

COD. 32132
BULKYSOFT

SERVIETTEN 24x24 1/4
WEISS



3



1/4



100%
Pure



RAND



24x24cm



80x30

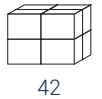

42

SERVIETTEN 24x24



2



100%
Pure



RAND



1/4



24x24cm



100x30



42



COD. 32500
BULKYSOFT
WEISS



COD. 32580
BULKYSOFT
RAINBOW
CREME



COD. 32036
BULKYSOFT
RAINBOW
LACHS



COD. 32630
BULKYSOFT
RAINBOW
BLAU



COD. 32590
BULKYSOFT
RAINBOW
GELB



COD. 32231
BULKYSOFT
RAINBOW
FUCHSIA



COD. 32640
BULKYSOFT
RAINBOW
GRÜN



COD. 32229
BULKYSOFT
RAINBOW
ZITRONE



COD. 32610
BULKYSOFT
RAINBOW
ROT



COD. 32234
BULKYSOFT
RAINBOW
KIWI



COD. 32288
BULKYSOFT
RAINBOW
ROSA



COD. 32620
BULKYSOFT
RAINBOW
BORDEAUX



COD. 32235
BULKYSOFT
RAINBOW
GRAU



COD. 32600
BULKYSOFT
RAINBOW
ORANGE



COD. 32233
BULKYSOFT
RAINBOW
LILA



COD. 32660
BULKYSOFT
RAINBOW
BRAUN



COD. 32289
BULKYSOFT
RAINBOW
HELLBLAU



COD. 32670
BULKYSOFT
RAINBOW
SCHWARZ

TABLE TOP SERVIETTEN



SERVIETTEN 30x30 - 1/4

COD. 32995
BULKYSOFT

SERVIETTEN 30x30
WEISS



1



1/4



100%
Pure



FLÄCHE



30x30cm



100x40



28

COD. 32130
BULKYSOFT

SERVIETTEN
30x30 COMPACT
WEISS



1



1/4



100%
Pure



FLÄCHE



30x30cm



500x10



32

SERVIETTEN 33x33 - 1/4



1



100%
Pure



FLÄCHE



1/4



33x33cm



500X6



40



COD. 32140
BULKYSOFT
WEISS

TABLETOP



COD. 32124
BULKYSOFT
RAINBOW
CREME

COD. 32129
BULKYSOFT
RAINBOW
GELB

COD. 32128
BULKYSOFT
RAINBOW
ROT

COD. 32125
BULKYSOFT
RAINBOW
BORDEAUX

COD. 32127
BULKYSOFT
RAINBOW
BLAU

COD. 32126
BULKYSOFT
RAINBOW
GRÜN

TABLE TOP



SERVIETTEN 33x33 - 1/4

COD. 32980
BULKYSOFT

SERVIETTEN 33x33
WEISS



2



1/4



100%
Pure



RAND



33x33cm



100x20



36

COD. 32290
BULKYSOFT

SERVIETTEN 33x33
WEISS



2



1/4



100%
Pure



RAND



33x33cm



50x40



30

SERVIETTEN 33x33 - 1/4



2



100%
Pure



RAND



1/4



33x33cm



50x24



40

COD. 32680
BULKYSOFT
RAINBOW
CREME

COD. 32037
BULKYSOFT
RAINBOW
LACHS

COD. 32740
BULKYSOFT
RAINBOW
BLAU

COD. 32700
BULKYSOFT
RAINBOW
GELB

COD. 32237
BULKYSOFT
RAINBOW
FUCHSIA

COD. 32750
BULKYSOFT
RAINBOW
GRÜN

COD. 32236
BULKYSOFT
RAINBOW
ZITRONE

COD. 32730
BULKYSOFT
RAINBOW
BORDEAUX

COD. 32241
BULKYSOFT
RAINBOW
KIWI

COD. 32020
BULKYSOFT
RAINBOW
ROSA

COD. 32720
BULKYSOFT
RAINBOW
ROT

COD. 32242
BULKYSOFT
RAINBOW
GRAU

COD. 32710
BULKYSOFT
RAINBOW
ORANGE

COD. 32239
BULKYSOFT
RAINBOW
LILA

COD. 32760
BULKYSOFT
RAINBOW
BRAUN

COD. 32030
BULKYSOFT
RAINBOW
HELLBLAU

COD. 32770
BULKYSOFT
RAINBOW
SCHWARZ

TABLE TOP SERVIETTEN

SERVIETTEN 33x33 - 1/4

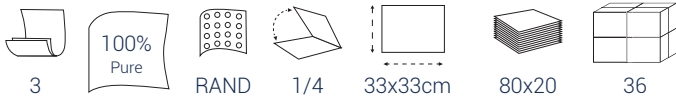

COD. 32035
BULKYSOFT
WEISS

 **COD. 32053**
BULKYSOFT
RAINBOW
CREME

 **COD. 32054**
BULKYSOFT
RAINBOW
GELB

 **COD. 32056**
BULKYSOFT
RAINBOW
LACHS

 **COD. 32057**
BULKYSOFT
RAINBOW
BORDEAUX

 **COD. 32055**
BULKYSOFT
RAINBOW
ROT

 **COD. 32058**
BULKYSOFT
RAINBOW
BLAU

 **COD. 32059**
BULKYSOFT
RAINBOW
GRÜN

 **COD. 32135**
BULKYSOFT
RAINBOW
KIWI

 **COD. 32131**
BULKYSOFT
RAINBOW
SCHWARZ



TABLE TOP

SERVIETTEN

SERVIETTEN 40x40 - 1/4

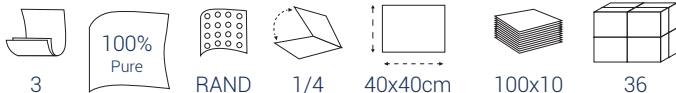

COD. 32100
BULKYSOFT
WEISS

COD. 32025
BULKYSOFT
RAINBOW
CREME

COD. 32271
BULKYSOFT
RAINBOW
FUCHSIA

COD. 32032
BULKYSOFT
RAINBOW
BLAU

COD. 32026
BULKYSOFT
RAINBOW
GELB

COD. 32029
BULKYSOFT
RAINBOW
BORDEAUX

COD. 32033
BULKYSOFT
RAINBOW
GRÜN

COD. 32269
BULKYSOFT
RAINBOW
ZITRONE

COD. 32028
BULKYSOFT
RAINBOW
ROT

COD. 32136
BULKYSOFT
RAINBOW
KIWI

COD. 32027
BULKYSOFT
RAINBOW
ROSA

COD. 32273
BULKYSOFT
RAINBOW
LILA

COD. 32274
BULKYSOFT
RAINBOW
GRAU

COD. 32041
BULKYSOFT
RAINBOW
LACHS

COD. 32031
BULKYSOFT
RAINBOW
HELLBLAU

COD. 32034
BULKYSOFT
RAINBOW
SCHWARZ

SERVIETTEN 40x40 - 1/8 KOPFFALZ

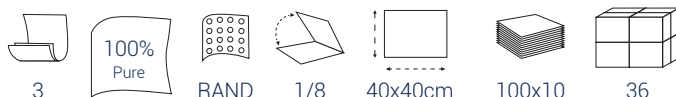

COD. 32110
BULKYSOFT
WEISS

COD. 32134
BULKYSOFT
RAINBOW
CREME

COD. 32223
BULKYSOFT
RAINBOW
ROT

COD. 32142
BULKYSOFT
RAINBOW
GRÜN

COD. 32225
BULKYSOFT
RAINBOW
GELB

COD. 32226
BULKYSOFT
RAINBOW
BLAU

COD. 32228
BULKYSOFT
RAINBOW
SCHWARZ

COD. 32224
BULKYSOFT
RAINBOW
BORDEAUX

TABLE TOP SERVIETTEN



Linen Line

BESTECKTASCHEN MIT SERVIETTE



100%
Pure



RAND



1/8



38x38cm



125x8



28

AIRLAID SERVIETTEN 40x40 - 1/4



1



Airlaid



OHNE



1/4



40x40cm



50x10



48



COD. 32116
BULKYSOFT
LINEN LINE
WEISS



COD. 32121
BULKYSOFT
LINEN LINE
BLAU



COD. 32117
BULKYSOFT
LINEN LINE
CREME



COD. 32119
BULKYSOFT
LINEN LINE
GRÜN



COD. 32122
BULKYSOFT
LINEN LINE
BORDEAUX



COD. 32991
BULKYSOFT
LINEN LINE
BRAUN



COD. 32118
BULKYSOFT
LINEN LINE
ROT



COD. 32123
BULKYSOFT
LINEN LINE
SCHWARZ



COD. 18370
BULKYSOFT
WEISS - COATED KRAFT



COD. 18390
BULKYSOFT
WEISS - COUNTRY - COATED KRAFT



COD. 18400
BULKYSOFT
WEISS - SAILOR - COATED KRAFT



COD. 18380
BULKYSOFT
OCKER



Linen Line

AIRLAID BESTECKTASCHEN 40x40 - 1/8 BUCHFALZ



1



Airlaid



OHNE



1/8



40x40cm



54x16



30



COD. 32297
BULKYSOFT
LINEN LINE
WEISS



COD. 32299
BULKYSOFT
LINEN LINE
BRAUN

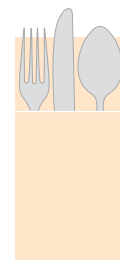

COD. 32301
BULKYSOFT
LINEN LINE
CREME

TABLE TOP

TISCHSETS 30x40

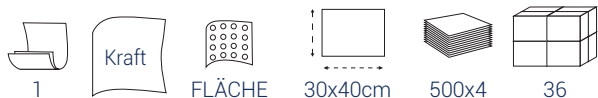

COD. 18040
BULKYSOFT
TISCHSETS
WEISS

COD. 18120
BULKYSOFT
TISCHSETS
CREME

COD. 18130
BULKYSOFT
TISCHSETS
GELB

COD. 18080
BULKYSOFT
TISCHSETS
ORANGE

COD. 18140
BULKYSOFT
TISCHSETS
ROT

COD. 18150
BULKYSOFT
TISCHSETS
BORDEAUX

COD. 18160
BULKYSOFT
TISCHSETS
BLAU

COD. 18170
BULKYSOFT
TISCHSETS
GRÜN

COD. 18410
BULKYSOFT
TISCHSETS
BRAUN

COD. 18420
BULKYSOFT
TISCHSETS
SCHWARZ

MITTELDECKEN

100x100 EXCELLENCE

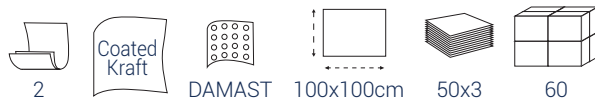

COD. 18210 EXCELLENCE
BULKYSOFT
MITTELDECKEN
WEISS

COD. 18220 EXCELLENCE
BULKYSOFT
MITTELDECKEN
CREME

COD. 18230 EXCELLENCE
BULKYSOFT
MITTELDECKEN
GELB

COD. 18240 EXCELLENCE
BULKYSOFT
MITTELDECKEN
ORANGE

COD. 18250 EXCELLENCE
BULKYSOFT
MITTELDECKEN
ROT

COD. 18260 EXCELLENCE
BULKYSOFT
MITTELDECKEN
BORDEAUX

COD. 18270 EXCELLENCE
BULKYSOFT
MITTELDECKEN
BLAU

COD. 18280 EXCELLENCE
BULKYSOFT
MITTELDECKEN
GRÜN

COD. 18290 EXCELLENCE
BULKYSOFT
MITTELDECKEN
BRAUN

COD. 18300 EXCELLENCE
BULKYSOFT
MITTELDECKEN
SCHWARZ



TABLE TOP TISCHTUCHROLLEN

TISCHTUCHROLLEN 7 m EXCELLENCE

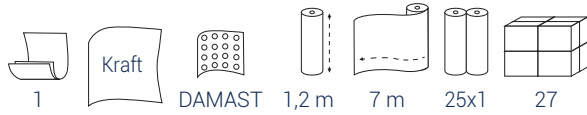

COD. 18440 EXCELLENCE
BULKYSOFT
TISCHTUCHROLLEN
WEISS



COD. 18480 EXCELLENCE
BULKYSOFT
TISCHTUCHROLLEN
GELB

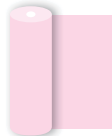

COD. 18450 EXCELLENCE
BULKYSOFT
TISCHTUCHROLLEN
ROSA



COD. 18470 EXCELLENCE
BULKYSOFT
TISCHTUCHROLLEN
ROT



COD. 18460 EXCELLENCE
BULKYSOFT
TISCHTUCHROLLEN
HELLBLAU



COD. 18490 EXCELLENCE
BULKYSOFT
TISCHTUCHROLLEN
BLAU



COD. 18500 EXCELLENCE
BULKYSOFT
TISCHTUCHROLLEN
GRÜN

TISCHTUCHROLLEN 50 m EXCELLENCE

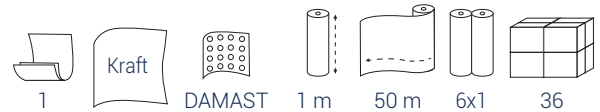

COD. 18340
BULKYSOFT
TISCHTUCHROLLEN
WEISS



COD. 18530 EXCELLENCE
BULKYSOFT
TISCHTUCHROLLEN
GELB



COD. 18510 EXCELLENCE
BULKYSOFT
TISCHTUCHROLLEN
ROT



COD. 18540 EXCELLENCE
BULKYSOFT
TISCHTUCHROLLEN
BLAU



COD. 18520 EXCELLENCE
BULKYSOFT
TISCHTUCHROLLEN
GRÜN



STARTER KIT



STARTERKIT

STARTER KIT

PLUSPUNKTE



COD. 02000
TOILETTPAPIER
MINI JUMBO



1 Spender + 1 Befüllung
2 lagig
145 m



ZERTIFIZIERTE
PRODUKTE



VERRINGERUNG
LAGERBESTAND



COD. 02001
TOILETTPAPIER
EINZELBLATT

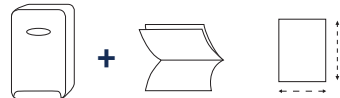

1 Spender + 2 Befüllung 110x190 mm



SPENDER GEEIGNET IN
KLEINEN UND GROSSEN
UMGEBUNGEN



ERKENNBARE UND
NEUTRALE LINIE



COD. 02002
PAPIERHANDTÜCHER W FALZ



1 Spender + 2 Befüllung 205x420 mm



GERINGERE KOSTEN
DER INSTALLATION



EINFACHE LÖSUNG,
GERBAUCHSFERTIG



COD. 02003
PAPIERHANDTÜCHER M FALZ

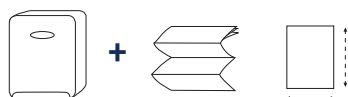

1 Spender + 2 Befüllung 215x320 mm



COD. 02004
SCHAUMSEIFE



1 Spender + 1 Befüllung 1000 ml



COD. 01090

BULKYSOFT

SPENDER FÜR MAXI JUMBOROLLEN

Transp. WEISS

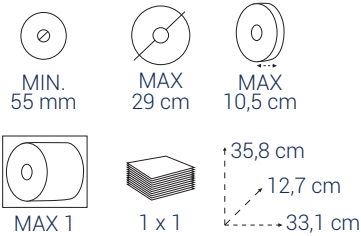

COD. 01100

BULKYSOFT

SPENDER FÜR MINI JUMBOROLLEN

Transp. WEISS

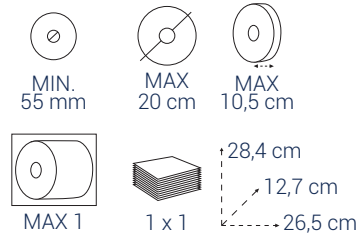

COD. 01110

BULKYSOFT

SPENDER FÜR EINZELBLATT TOILETTPAPIER

Transp. WEISS

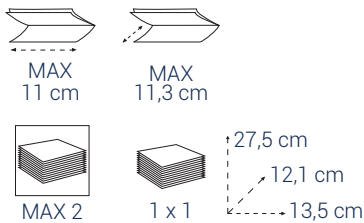

COD. 01010

BULKYSOFT

SPENDER FÜR PAPIERHANDTÜCHER - V-UND K-FALZ

Transp. WEISS

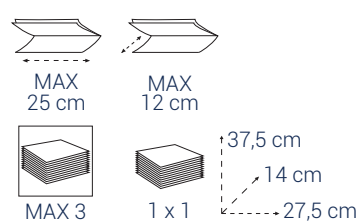

COD. 01020

BULKYSOFT

SPENDER FÜR PAPIERHANDTÜCHER - C- Z-UND M-FALZ

Transp. WEISS

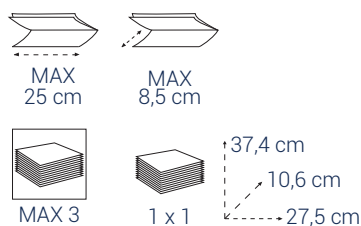

COD. 01345

BULKYSOFT

SPENDER AUTOCUT SYSTEM

WEISS

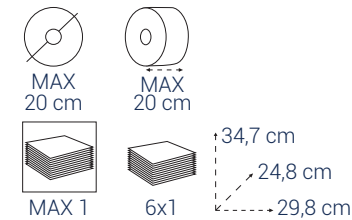

COD. 01140

BULKYSOFT

SPENDER AUTOCUT SYSTEM

WEISS

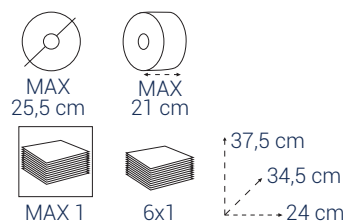

SYSTEMS

COD. 01050

BULKYSOFT
SEIFENSPENDER FÜR KARTUSCHEN

Transp. WEISS

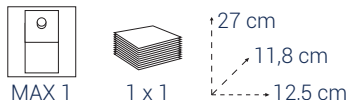

COD. 01150

BULKYSOFT
SPENDER FÜR RAUMDUFT

Transp. WEISS

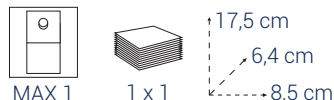

COD. 01040

BULKYSOFT
SCHAUMSEIFENSPENDER FÜR KARTUSCHEN

Transp. WEISS

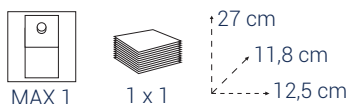

COD. 01260

BULKYSOFT
SPENDER FÜR HYGIENEBEUTEL

WEISS

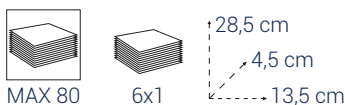

COD. 01270

BULKYSOFT
SPENDER FÜR TOILETTENSITZAUFLAGE

WEISS

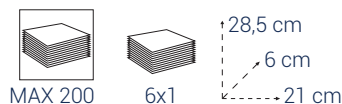

COD. 01280

BULKYSOFT
ABFALLBEHÄLTER MIT SCHWENKDECKEL 30 LITER



COD. 01250

BULKYSOFT
KOSMETIKTUCHSPENDER 100 STÜCK

WEISS

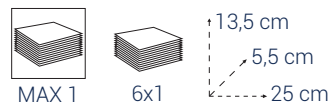

COD. 01120

BULKYSOFT
SPENDER FÜR MEDIUM HANDTUCHROLLEN

Transp. WEISS

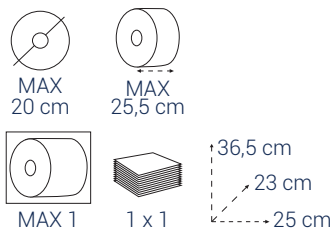

COD. 01130

BULKYSOFT
SPENDER FÜR MINI HANDTÜCHROLLEN

Transp. WEISS

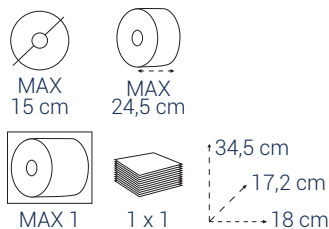

COD. 01300

BULKYSOFT

SPENDER FÜR INDUSTRIEROLLEN, GESCHLOSSEN, HACCP ZERTIFIZIERT

Transp. WEISS/BLAU

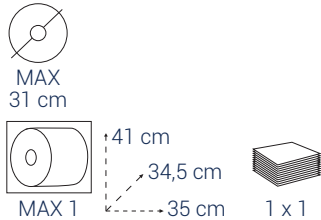

COD. 01310

BULKYSOFT

WANDHALTERUNG FÜR INDUSTRIEROLLEN CHROM

WEISS CHROM

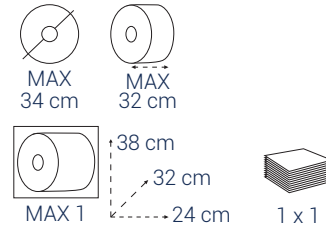

COD. 01320

BULKYSOFT

BODENSTÄNDER FÜR INDUSTRIEROLLEN

CHROM

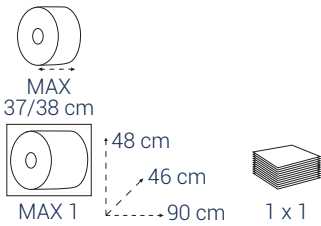

COD. 01341

BULKYSOFT

SERVIETTENSPENDER
SYSTEM ONE
STAND MODEL



COD. 01342

BULKYSOFT

SERVIETTENSPENDER
SYSTEM ONE
TISCH MODEL



COD. 01190

BULKYSOFT

SERVIETTENSPENDER

WEISS

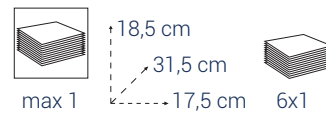

Sauberkeit und Hygiene aus Leidenschaft !

	PRÄGUNG
	LAGEN
	BLATTFORMAT
	HÖHE
	ROLLENDURCHMESSER
	KERNDURCHMESSER
	TIEFE MAX
	BREITE MAX
	ROLLENLÄNGE
	BLATTANZAHL
	BLATTLÄNGE
	FALZUNG (1/2 • 1/4 • 1/8)
	FALZ
	N. STK. X SPENDER
	VERPACKUNGSEINHEIT
	PALETTENEINHEIT



Sauberkeit und Hygiene aus Leidenschaft!

ALEMEX HandelsgesmbH Tel.: +43(0)2282/61-701
Erste Strasse 1 Fax.:+43(0)2282/61-702
2284 Unteresiebenbrunn e-mail: office@alemax.at
Österreich web.: www.alemax.at

